

2012 Sale Donkey List

Lot # Miniature Donkey

- 1 The Elms Black Beauty
- 2 Ass-Pirin Acres Simply Dazzling
- 3 Assphalt Acres Haven
- 4 Hill Co Minis Ariel **
- 5 The Elms Just Precious
- 6 Arcadian Ivy
- 7 Hill's Haven Sienna
- 8 HCF Enchanted Pixie
- 9 KKR Racine**
- 10 Ass-Pirin Acres Drama Queen
- 11 Designer Donkeys Miss Alred
- 12 Continental Indiana Patches
- 13 Wind Song's Lea**
- 14 Heiken's Ark Gypsy LB
- 15 Ass-Pirin Acres Tammi
- 16 Arcadian Mocha
- 17 The Elms People Magnet & Foal**^
- 18 Hill's Haven Suki
- 19 Cedar Grove Pretty Penny
- 20 Hill Co Mini's Sugar Baby
- 21 The Elms Bobbi Lou

Lot # Miniature Donkey

- 22 Heiken's Ark Essie K
- 23 Hill's Haven Lola
- 24 Assphalt Acres Reeces Pieces
- 25 West Prairie Jayla & Foal**^
- 26 Ass-Pirin Acres Miss Abegail
- 27 HCF Angelica June
- 28 Designer Donkeys Venus
- 29 The Elms Spice is Nice
- 30 Hill Co Mini's Eternity
- 31 Continental Misty Morning
- 32 RBF Buck++
- 33 Arcadian Melody II
- 34 Ass-Pirin Acres Twinkle Toes
- 35 Braying Hills Cherry-ette**
- 36 Shadows Ranch Sid's Bubbles
- 37 Ass-Pirin Acres Angelica
- 38 Hill Co Minis Solara
- 39 Hill's Haven Vakita
- 40 Arcadian Angel
- 41 Heiken's Ark Velvet KT
- 42 The Elms Chica Boom**

^ Foal by side ** Bred / Bred back ++ Driving Donkey with Harness

See WWW.DONKEYS.NET for Pictures

2013 Great American Miniature Donkey Sale
Sale Day – Saturday, July 27, 2013

Now is the time to select those special donkeys you will want to represent your farm breeding program in the 2013 Sale. Sale planning begins in December, deadline early March. Contact us anytime to discuss potential entries and details.

The Great American Miniature Donkey Sale LLC, copyright 2012



Saturday July 28, 2012
Historic Lebanon, Ohio - Fairgrounds

.....
10th Annual Sale Featuring Select Miniature Donkeys
Offered by Breeders from Across North America

*Quality Conformation, Diverse Pedigrees, All Colors,
 Jennets - Yearlings, 2 year olds, Mature, Bred and With Foal
 & Driving Gelding With Harness*

.....
Visit WWW.DONKEYS.NET for
Web Catalog with pictures

Sale Sponsors
The Great American Miniature Donkey Sale LLC
The Elms Farm - Elms Farm Miniature Donkeys
Martha & Dowell Howard
Mason, Ohio
mhoward@eos.net
513-225-1771, 513-398-3341. 513-919-5613

Welcome To
The Great American Miniature Donkey Sale
Historic Lebanon, Ohio
At the Warren County Fairgrounds

June, 2012

Dear Donkey Enthusiast,

We are pleased to invite you to 10th annual Great American Miniature Donkey Sale, a select sale featuring quality registered miniature donkeys. The Sale will take place on Saturday, July 28, 2012 at 12:30 PM, in Building C at the Warren County Fair - grounds, 660 N. Broadway, Lebanon, Ohio 45036. We hope you plan to attend.

The Sale will consist of 42 miniature donkey lots. These miniature donkeys have been selected from those offered for consideration. Top breeders are consigning their best, as these donkeys publicly represent their farm and breeding program. It would literally take you many days, and thousands of miles, to view an assortment of available, quality stock like you will see represented at the Sale.

The selected miniature donkeys represent diverse bloodlines, great conformation, and a variety of sizes, colors & ages to attract breeders, show people, and donkey & equine lovers everywhere. Full information on each, including pictures (as consignors make them available), may be found on the web page, www.donkeys.net.

There is something for everyone here, whether you are an experienced breeder, or just getting started. Jennets include; yearlings, coming 2 year olds, mature jennets, bred jennets, and jennets with foals on the side. A trained driving gelding & harness is being offered, with a cart available separately. Donkey tack and gifts will be available for purchase. Whether you are looking for a jennet, a jennet with foal, brood jennets for your breeding program, a driving gelding ready to go or a loving pet, you are assured of finding only quality miniature donkeys at this sale.

This Donkey Sale is more than just an auction; it is an event, a 'happening'. Donkey enthusiasts everywhere look forward to events such as this and we expect a large turnout from across the Continent. It is an opportunity for folks, both those with years of experience, and those first exploring miniature donkeys, to get together, share experiences, learn from each other, have some fun, make new friends, renew old friendships, and, oh yes, see, bid on, and purchase some of the finest quality miniature donkeys in North America

We hope you plan to attend this year's Great American Miniature Donkey Sale. We are confident you will enjoy it.

Thank You for Your Support

Martha L. Dowell Howard

Absentee Bidding – You must be registered prior to the Sale to phone bid or to bid through another person. Do this early. Please review registration details at www.donkeys.net or call 513-398-3341, 513-225-1771 or 513-919-5613.

Sale Day Telephones: 513-225-1771 and 513-919-5613.

The Great American Miniature Donkey Sale, LLC
Schedule of Events

FRIDAY JULY 27, 2012 SALE SET-UP DAY

Friday is primarily a set-up and check-in day for the Sale. All donkeys must be on site by 4:00 to allow for consignor and vet check-in. There will be limited viewing during the late afternoon. Events are planned as follows:

Viewing Begins	3:00
Consignor's Invitational Dinner	6:00
Measurement	7:00

SATURDAY JULY 28, 2012 SALE DAY

Saturday is the Sale Day. Viewing will begin at 8:00. Breakfast & lunch will be available for purchase. The Donkey Sale starts at 12:30 and checkout begins shortly after the last lot is sold. Donkey tack, gifts, useful items and curios will be available.

Viewing Starts	8:00
Sale Vendors	9:00
Sale Starts	12:30
Payment, Vet Papers	Shortly after last lot is sold
All Donkeys Removed	before 8:00 PM

SALE LOCATION & DIRECTIONS

The Sale will be held at the Warren County Fairgrounds, Bldg C, adjacent to Lebanon Raceway, on Route 48, (660 N. Broadway, Lebanon, OH 45036), 0.7 miles north of the town center of Lebanon, OH. The Lebanon Raceway, a private company, will be in operation, so no parking on paved areas. Parking for the Sale will be marked.

From I-75, take exit #29 (Monroe, Lebanon, Rt 63) east to Lebanon, 7 miles. Turn left on Broadway (Rt 48 North), go 0.7 miles to the Fairground.

From I-71, take exit #28 (Rt 48), turn North, go about 2 miles to Rt 123, exit west toward Lebanon, go 1 mile, turn right on Broadway, go 0.7 miles to the Fairground

Auctioneering & Clerking

Kevin Wendt, Auctioneer

23855 State Route 161

Irwin, OH 43029

419-566-1599

www.thewendtgroup.com

kevin@thewendtgroup.com

The Great American Miniature Donkey Sale LLC

TERMS AND CONDITIONS

Terms: Cash or good check with photo ID. **No credit cards.** Checkout at Sale end. No early checkout. All donkeys must be paid for immediately at sale end. No donkeys removed before payment after Sale. Donkeys must be removed by 8 PM. (We can help if you attend / phone bid, but won't have a trailer at the Sale.)

Bidding: All donkeys sell to the highest bidder. Any disputes or challenges will be settled by the auctioneer, and his decision will be final. The auctioneer may reject any or all bids. Bids are per lot. Jennets with foals on the side sell as one lot.

Risk: Owners assume all risk for their donkey up to the point of sale. Buyers assume all risk at the moment the auctioneer declares the donkey sold. Under Ohio Law, all persons attending the Sale do so at their own risk. The Management, their staff, auctioneers & their staff do not assume responsibility for, and disclaim any liability of any kind for accidents, loss (also animals), and/or personal property damages.

Announcements: Sale day announcements from the auction block take precedence over the material in the catalog or on the web. Every effort has been made to ensure the accuracy of the catalog and web material. However, we assume no liability for errors or omissions from any source.

Contract: The management, auctioneers, and employees act as agents for the seller, but assume no liability for either the buyer or the seller. Any representations made by the sales management are made on behalf of the seller.

The above terms and conditions shall constitute a contract between the buyer and the seller of each animal sold. All guarantees are between buyer and seller.

Health: The EIA/Coggins test will be less than 3 months old. Current health papers for transportation will be good for 7 days past sale date. Proof of pregnancy from a veterinarian is required for bred jennets, otherwise sold as exposed. **Buyers are responsible to obtain the paperwork they need from the veterinarian after payment immediately following the Sale.**

Transport: We may be able to help you get your donkey(s) home. Please let us know if you may need this assistance.

Export: Export buyers will assume all related export costs such as veterinary work, quarantine, shipping, etc. For further clarification, contact us, we export frequently.

General: Please note that information in the catalog has been provided by the consignors. Height data may be birth, immature or adult registered heights and are included only as helpful data. All donkeys will be measured in public view on Friday at the time shown on the schedule. We encourage you to personally inspect the donkeys you are interested in and / or talk with or contact the consignors.

Absentee / Phone Bids

Please contact Martha or Dowell Howard at, 513-225-1771, 513-919-5613, or 513-398-3341 or email at mhoward@eos.net by the Wednesday before the Sale

Please Bring This Catalog – Supplies Are Limited

The Great American Miniature Donkey Sale LLC

Camping & Lodging

Camping: Camping available at the Fairgrounds for \$20. Water & electric hook-ups, dump station, restrooms & **HOT** showers. 250 ft from the Sale. Pay Martha.

Motels & B&B

Motel	Miles from Sale	Address	Phone	Web
Lebanon				
The Golden Lamb	1	27 S Broadway	513-932-5065	goldenlamb.com
Shaker Inn	2	600 Cincinnati Av.	513-932-7575	shakerinnmotel.com
Hatfield Inn B&B	5	2563 Hatfield Rd	513-932-3193	bbonline.com/oh/hatfield/
Mason (I-71, Exit 25 - Rt 741)				
Kirkwood Inn	9	4030 S US Rte 42	513-398-7277	kirkwoodinn.com
Super 8 Motel	9	5589 Kings Mills Rd	513-398-8075	super8.com
Hampton Inn	9	5323 Beach Blvd	513-459-8900	hamptoninn.com
Comfort Suites	9	5457 Kings Center Dr.	513-336-9000	comfordsuites.com
Baymont Inn	9	2793 WaterPark Dr.	513-754-1166	baymontinns.com
Microtel Inn Suites	9	5324 Beach Blvd	513-754-1500	microtelinn.com
Mason (I-71, Exit 19 - Fields Ertel Rd)				
Days Inn	15	9735 Mason Montgomery	513-398-3297	daysinn.com
Red Roof Inn	15	9487 Bardes Rd	513-398-3633	redroof.com
Hyatt Place	15	5070 Natorp Blvd.	513-754-0003	hyattplace.com
La Quinta	15	9918 Escort Drive	513-459-1111	lq.com
Marriott	15	9664 Mason Montgomery	513-459-9800	marriott.com
West Chester (I-75, Exit 19 - West Chester)				
Marriott	17	6189 Mulhauser Rd	513-874-7335	www.marriott.com
West Chester (I-75, Exit 22 - Tylersville Rd)				
Wingate Inn	14	7500 Tylers Place Blvd	513-777-1101	www.wingatehotels.com
Monroe (I-75, Exit 29 - Rt 63)				
Howard Johnson	8	150 New Garver Rd	513-539-9221	www.hojo.com
Comfort Inn	8	120 Senate Dr	513-539-2660	www.comfortinn.com
Hampton Inn	8	40 New Garver Rd	513-539-4400	www.hamptoninn.com

Elms Farm Miniature Donkeys

We strive to produce quality miniature donkeys with excellent conformation, great dispositions and personalities

- * **Correct, drafty donkeys - Reds, Blacks, Darks, Spots & Woolies**
- * **Large red herd, the most genetically diverse anywhere.**
- * **Largest and most diverse wooly herd anywhere.**
- * **Herd Sires – Reds, Blacks, Dark Spots, Woolies**
- * **Breed stock selected from herds across North America**
- * **Each mating planned to strengthen desirable characteristics.**
- * **Foundation Herd Planning – Export Expertise**
- * **'Shipping around the Corner or Around the World'SM**

www.donkeys.net

2012 Consignor List

Arcadian Exotics, Paul and Gertrude Suorsa, 133 Branchton Rd.
Slippery Rock, PA 16057, 724-794-3288, c 724-556-1349,
arcadianexotics@gmail.com, www.arcadianexotics.com, **Lots 6, 16, 33 & 40**

Assphalt Acres, Steve and Jill Crim, 3640 N 775E, Manilla, IN 46150,
765-544-2567, c 317-402-3958, assphaltacres@yahoo.com,
www.assphaltacres.com, **Lots 3 & 24**

Ass-pirin Acres, Marshlyn and Michael Reed, 4241 Vt. Rt. 17W, Addison, VT
05491, 802-759-2665, minidonk@together.net, www.asspirinacres.com,
Lots 2, 10, 15, 26, 34 & 37

Cedar Grove Minis, Harlan Kaufmann, 679 Cedar Grove Rd., Burgettstown,
PA 15021, 724-947-9582, 724-554-5599, minirus@gmx.com, **Lots 19**

Continental Farm, Wayne and Joan Schuetz, 804 SE 11th St., Washington,
IN 47501, 812-254-0811, c 812-486-6809, continentalfarm@yahoo.com,
www.continentaldonkeys.com, **Lots 12 & 31**

Designer Donkeys, Sid & Jburd Ellis, 1106 Janehaven Lakes, Cleburne, TX
76033, 817-641-8057, 817-487-8979, jburdellis@yahoo.com,
www.designerdonkeys.com, **Lots 11 & 28**

Elms Farm Miniature Donkeys, Martha and Dowell Howard, 5600 Bethany
Rd., Mason, OH 45040, 513-398-3341, c 513-225-1771, c 513-919-5613,
mhoward@eos.net, www.donkeys.net,
Lots 1, 5, 9, 13, 17, 21, 25, 29, 35 & 42

Heiken's Ark, Dick and Kathy Heiken, PO Box 35456, Des Moines, IA 50315,
515-962-0667, c 515-360-5911, heikensark@aol.com, www.heikensark.com
Lots 14, 22 & 41

Hill Country Miniatures, Ed and Angela Preston, 339 E. Town East Blvd.,
Sunnyvale, TX 75182, 972-226-6386, c 817-729-7700,
draughonpreston@aol.com, www.hillcountryminiatures.com,
Lots 4, 20, 30, 38

Hill's Haven, Bill and Sue Hill, 3305 203rd St., Fort Madison, IA 52627,
319-372-3539, c 319-371-5761 hillshaven@q.com,
www.hillshavendonkeys.com, **Lots 7, 18, 23 & 39**

Horse Creek Miniatures, Wendy Herrick Nye, 9516 Mulberry Rd.,
Chesterland, OH 44026, 440-729-1422, pwnyehcf@gmail.com,
www.horsecreekfarm.net, **Lots 8, 27, & 36**

Ravenwood Farm, Jerry & Susie Patterson, 6128 S 1100 W, Hartsville, IN
47244, 812-546-6128, c 812-614-4451, ravenwoodmini@gmail.com,
www.ravenwoodfarm.com, **Lots 32**

1 The Elms *Black Beauty*

Black NLP Jennet, 5/20/11, Reg. #61557

Consignor: Elms Farm Miniature Donkeys, 28.25" March 2012

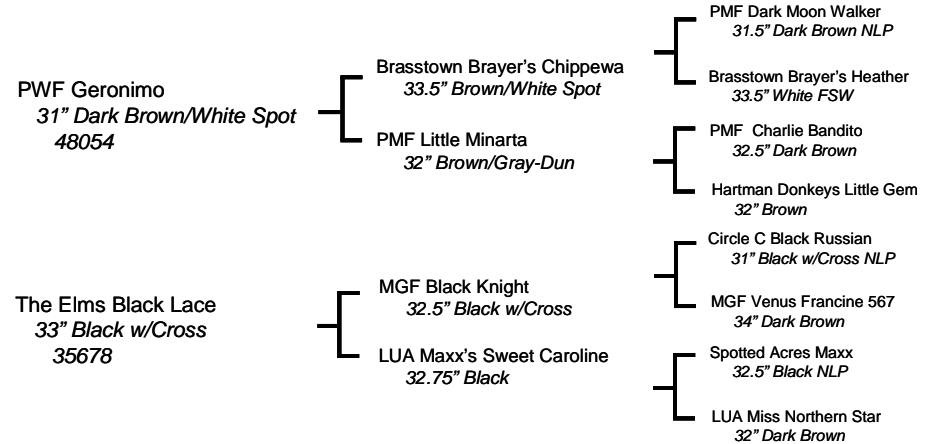

Splendid in her naturally glossy black coat, she is a true Black Beauty!
Prepare to fall in love, this little jenny will steal your heart! With her great
conformation, smooth build, and good temperament, she is everything you
could want!

2 Ass-pirin Acres *Simply Dazzling*

Red Jennet, 5/4/11, Reg. #62188

Consignor: Ass-Pirin Acres, 29.5" March 2012

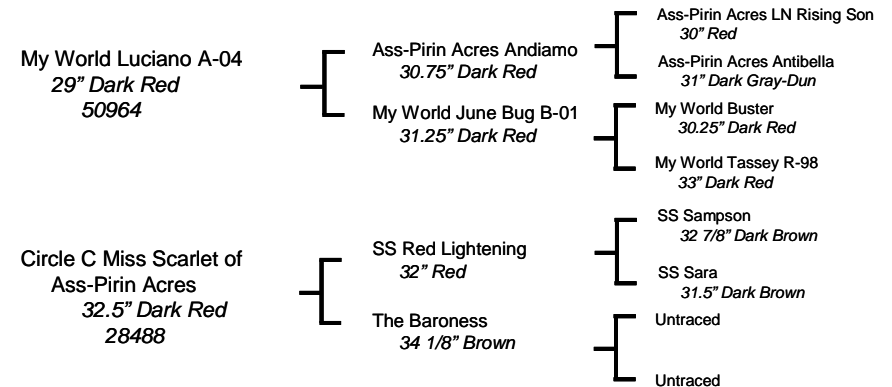

This little red jenny is the daughter of the famous Miss Scarlet, who took
the show ring in Canada by storm! Scarlet was known as the most perfectly
conformed jennet in Canada at that time. Simply Dazzling should excel in
the show ring and later in the breeding pen! Her documented pedigree is a
little light on her dam's side, but she makes up for it in every other way. You
will love her!

3 Assphalt Acres *Haven*

Dark Red Jennet, 4/26/11, Reg. #62454

Consignor: Assphalt Acres, 21" at Birth

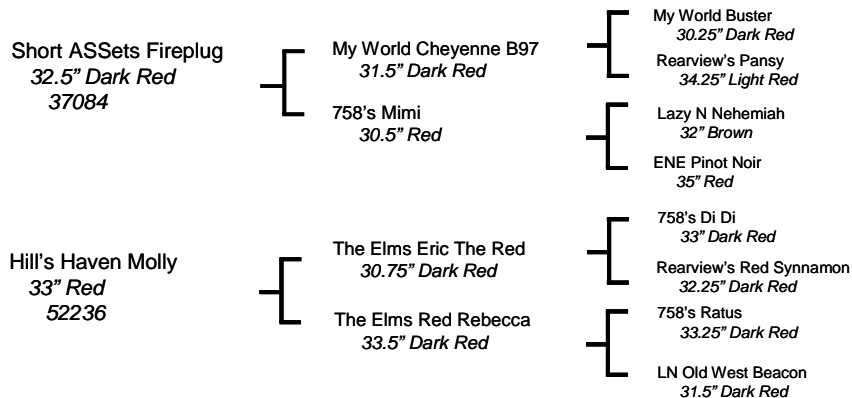

If you like red, then look at this little package. This girl not only has the color and great conformation, but also a great pedigree. Haven's half sister was the high seller at this sale in 2009. Her sire, Short Asset's Fireplug has sired many Champions. Buy this girl and take her right to the Show Ring!

4 Hill Co Mini's *Ariel*

Very Dark Brown Jennet, 4/20/09, Reg. #Pending

Consignor: Hill Country Miniatures, 32" March 2012, Bred for 2013

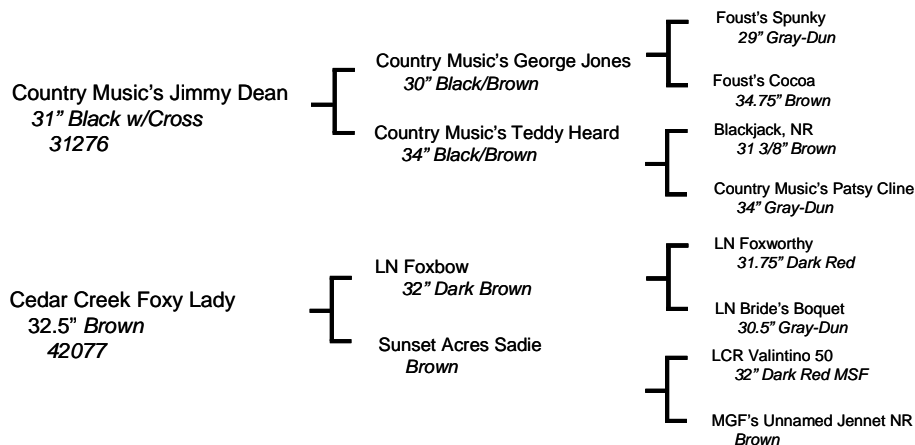

Ariel is a 32" very dark brown jennet bred to our 2011 National Spotted Color Champion, HHAA Sweet Spotz. Sweetie has been exported to the Netherlands, so this will be one of a few foals sired by him on this Continent. Ariel's pedigree is loaded with notable donkeys like Sunset Acres Sadie, Valintino 50 and Foxworthy. Ariel's mother sold in 2010 at this sale for \$4700.

5 The Elms *Just Precious*

Dark Red Jennet, 7/30/11, Reg. #Pending

Consignor: Elms Farm Miniature Donkeys, 25.25" Feb 2012

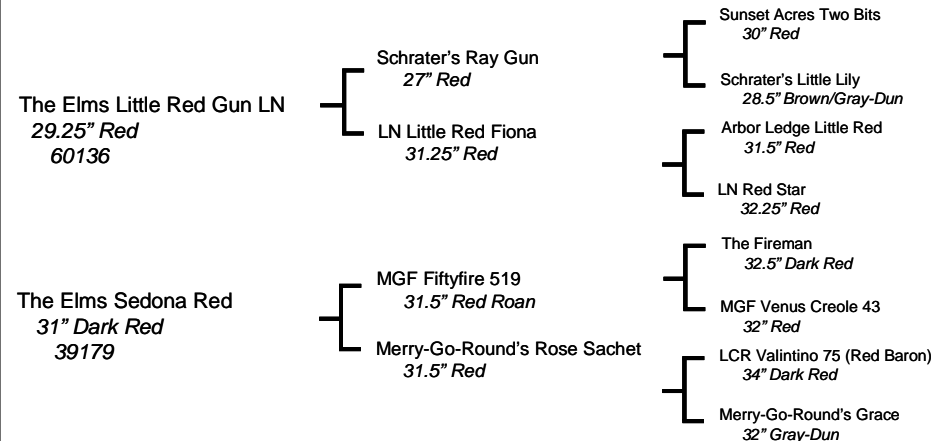

First jennet foal by our new red Herd Sire, Gunner! Her small size, wide chest, straight legs, good red color, and winning personality make her just so precious! Who can ask for more?

6 Arcadian *Ivy*

Gray-Dun Jennet, 5/13/11, Reg. #61708

Consignor: Arcadian Exotics, 19" at Birth

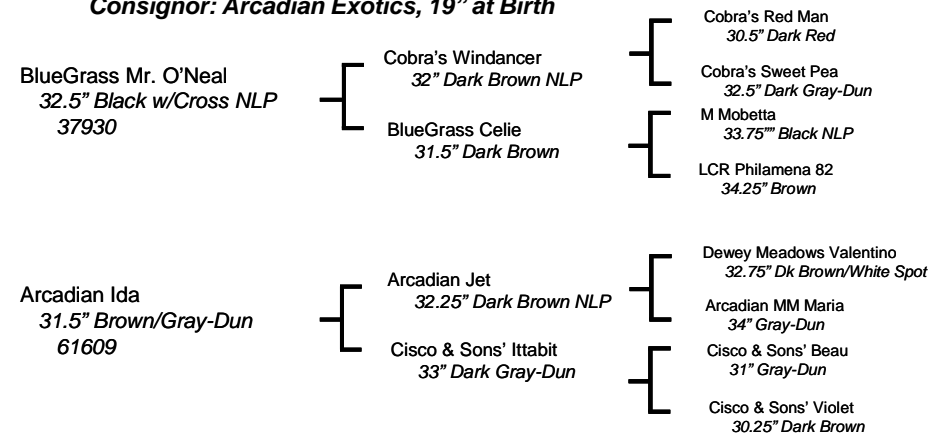

Ivy is probably the smallest jennet ever born on our farm, only 19" at birth. She's a beautiful flashy, small girl with an excellent pedigree. Her sire has produced many black foals and her dam passed her small size on to Ivy. Ivy's pedigree includes Dewey Meadows Valentino, a brown & white spotted jack who passed away last year. If you're looking for a future brood jennet, take a good look at Ivy before it's too late. Ivy can't be beat!

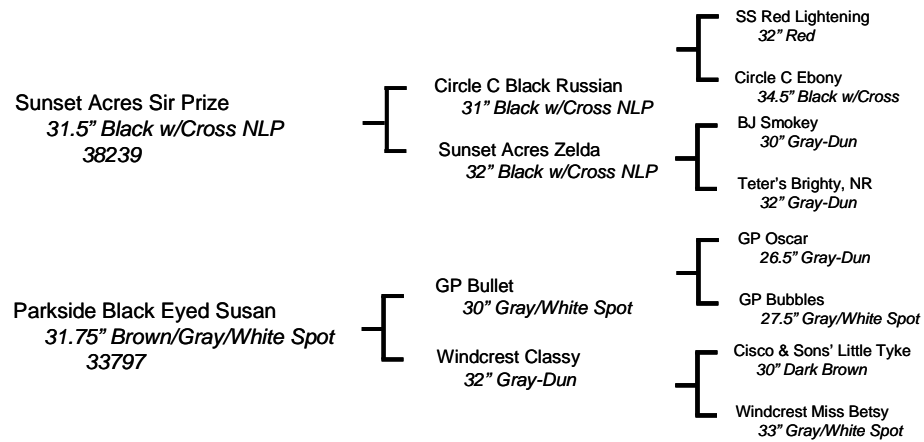
7 Hill's Haven *Sienna***Black w/Cross Jennet, 8/19/10, Reg. #60130****Consignor: Hill's Haven**

Sienna's a nice small, very correct black 2 year old jennet. Her pedigree has it all, blacks, spots, smalls and well known donkeys. Consider Sienna to enhance your black and / or spotted program. She's a lovely jennet!

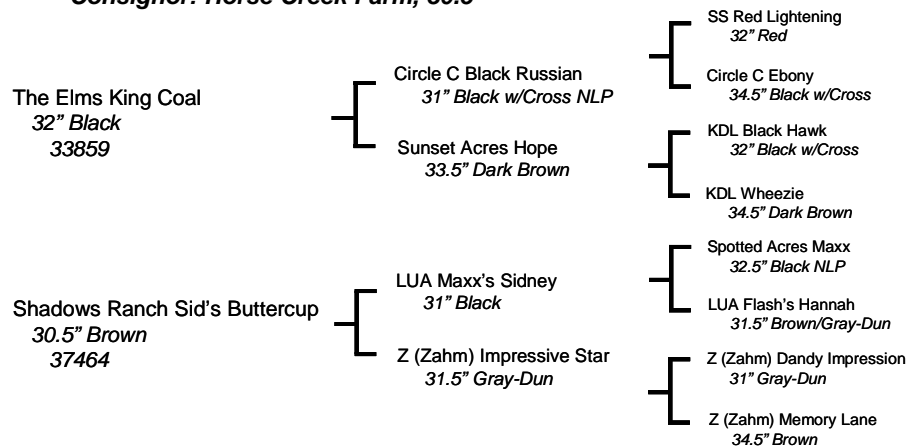
8 H.C.F. *Enchanted Pixie***Black Jennet, 3/27/08, Reg. #58401****Consignor: Horse Creek Farm, 30.5"**

If you want Black, Pixie is the jennet for you! Pixie's outstanding confirmation (That head! Those ears!) is a testament to her full and diverse pedigree. Her small size at 4 years old attracts you, and her gentle demeanor sucks you in. Her summer coat gives no hint of the wavy hair she develops come fall. Don't miss the chance have this beautiful black jennet grace your pasture.

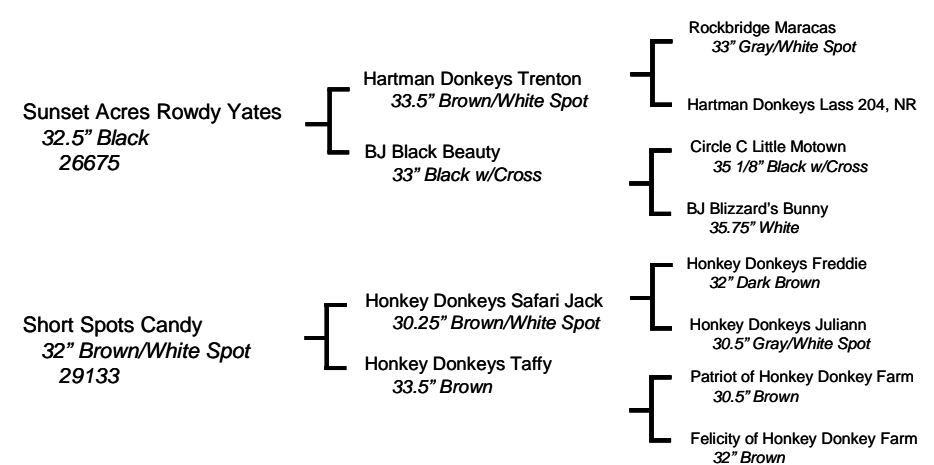
9 KKR *Racine***Dark Brown & White Spotted Jennet, 5/4/04, Reg. #39786****Consignor: Elms Farm Miniature Donkeys, 32.75", Bred for 2013**

Loved this jennet from the first time we saw her! Beautiful spotted pattern, very easy to work with, from the KKR show/training program. Racine's confirmed in foal to our very stocky, glossy black herd sire, Black Knight, for 2013.

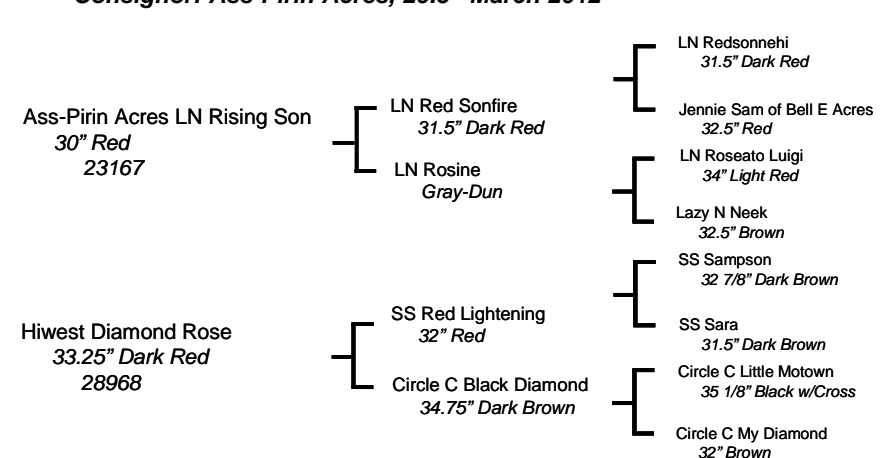
10 Ass-Pirin Acres *Drama Queen***Red Jennet, 4/19/11, Reg. #62187****Consignor: Ass-Pirin Acres, 29.5" March 2012**

This jennet is correct in all ways. Her pedigree has many of the 'Greats' – Lil Motown, Red Lightning, Valentino 50, Jennie Sam, Red Sonfire. Good breedings produce good foals. She is a showy girl with charm and smartness. She will be a strong asset in your herd.

11 Designer Donkeys *Miss Alred*

Dark Red Jennet, 9/23/11, Reg. #62224

Consignor: Designer Donkeys, 20" at Birth

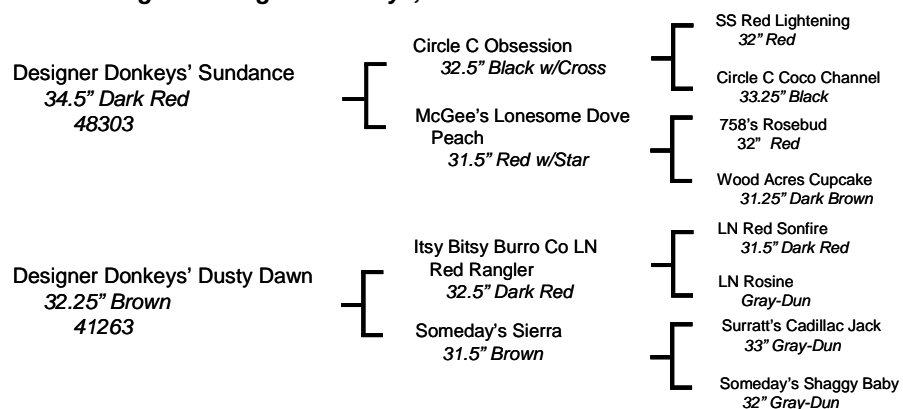

Miss Alred has very correct conformation, great legs, and a small head. She should mature a beautiful dark red. She has an excellent pedigree with many well known, nice donkeys. Her sire, Designer Donkeys Sundance, is an outstanding dark red jack by World Champion Circle C Obsession. Dusty Dawn, her dam, adds the dark red genetics of Red Rangler and Red Sonfire. Take a good look at Miss Alred!

12 Continental *Indiana Patches*

Red/Gray & White Spotted Jennet, 7/27/09, Reg. #57848

Consignor: Continental Farm

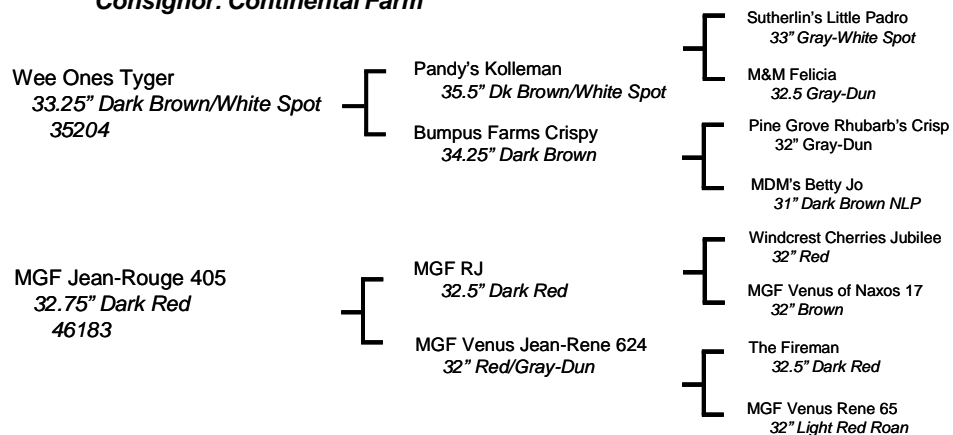

What do you get when you breed a beautiful red jennet to the 3x ACOSA National Champion, Wee Ones Tyger? You get Patches of course. She's out of Wayne's favorite jennet, Jean Rouge, an RJ daughter with a pedigree packed full of great reds. Her sire is a stunning spot. Patches took 2nd in a very large 2 year old class last year at the Indiana State fair. She's now 3 and has been left open for you to breed to the jack of your choice.

13 Wind Song's *Lea*

Dark Red Jennet, 9/6/02, Reg. #35977

Consignor: Elms Farm Miniature Donkeys, 32", Bred for 2013

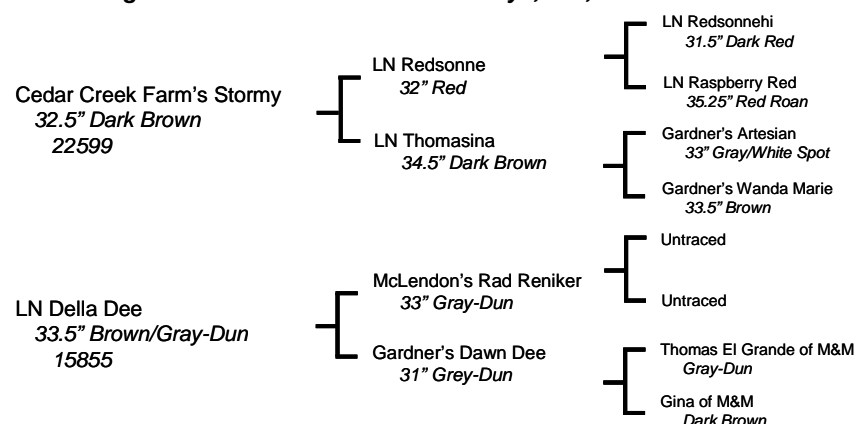

Can't find a prettier red jennet! Lea has a beautiful red coat, accented by the flashiest pure white legs and belly. With a round hip, smooth top line, she has had a number of very well conformed foals. We have used both a son and a daughter in our program. Lea is bred to our stocky, very correct, small dark red herd sire, The Elms Red Hot Wind, for a 2013 foal. Bound to be a great foal from this jennet and that sire!

14 Heiken's Ark *Gypsy LB*

Brown & White Spotted Jennet, 7/14/10, Reg. #Pending

Consignor: Heiken's Ark, 31.5" June 2012

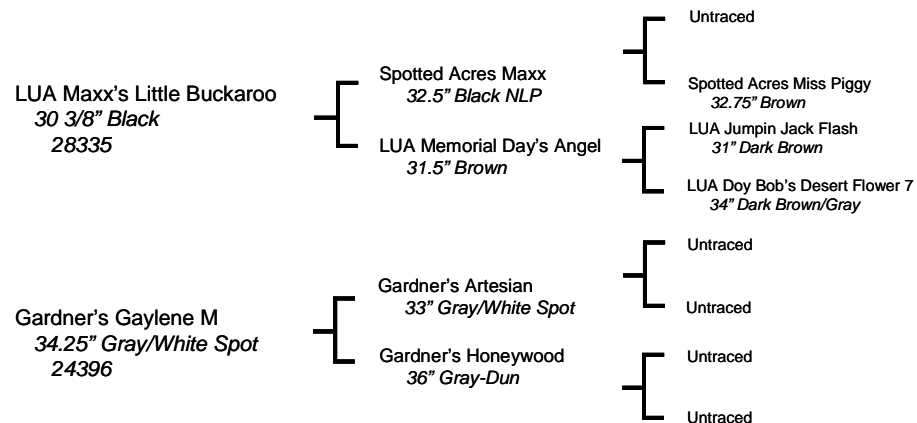

Gypsy gets her spots from her mom, and her stocky build and long hair from her dad. She will be clipped for the sale, but she did not lose all of the long hair as she was shedding off. She goes back to some early donkeys with registration numbers below 9,000. She has a lot to offer. Don't miss out.

15

Ass-Pirin Acres Tammi

Red Jennet, 5/23/11, Reg. #62190

Consignor: Ass-Pirin Acres, 21.5" at Birth

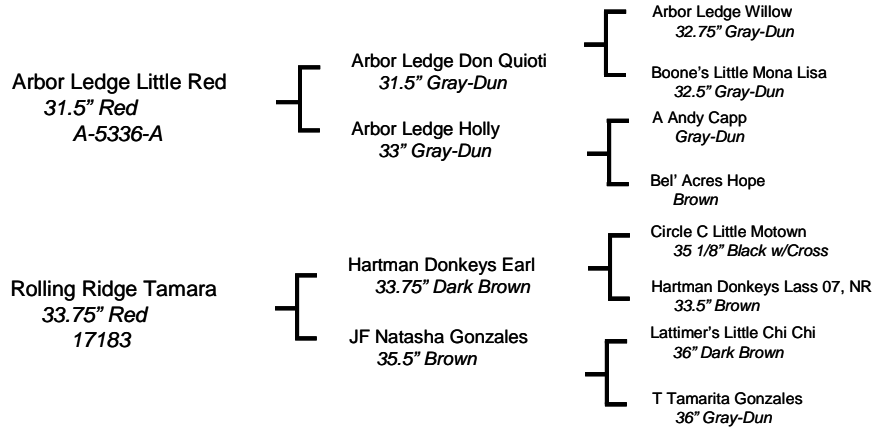

Wow! Little Red and Tamara have done it again! They have been so consistent with quality and color, and Tammi is one of the best. She is square, good bone, showy and smart. Very easy to work with and loves to be near you.

16

Arcadian Mocha

Brown Jennet, Jun 20, 2010, Reg. #61711

Consignor: Arcadian Exotics, 29.75" March 2012

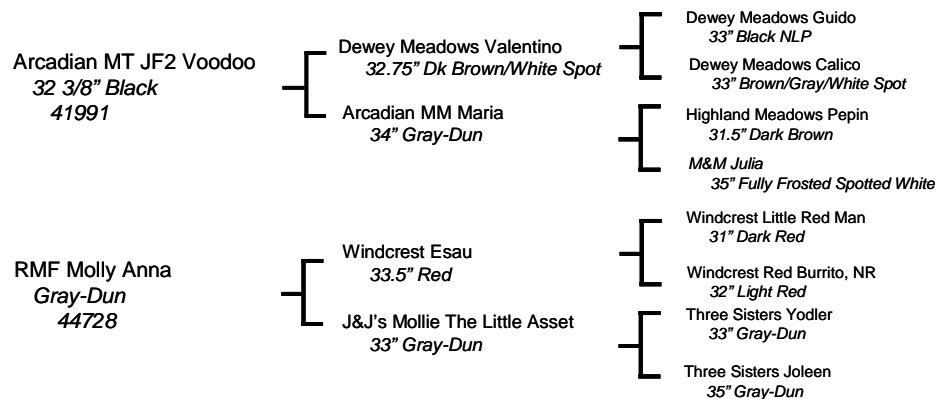

Mocha is a beautiful, small, correct, brown jennet. She has just turned 2 and will be ready to go to your jack before you know it. Her sire is a son of our Dewey Meadows Valentino, who unfortunately passed away at age 20 in 2010. Her dam has red all over her pedigree, so Mocha carries the red gene. To sum it all up, if you are looking for a new beautiful, small correct brood jennet, then Mocha's for you!

17

The Elms People Magnet

Dark Brown Jennet, 8/31/07, 32 1/8" Reg. #51998, Bred for 2013

The Elms Magnetism

Dark Brown NLP Jack Foal, 5/10/12, 21.5" at Birth, Reg. #Pending

Consignor: Elms Farm Miniature Donkeys

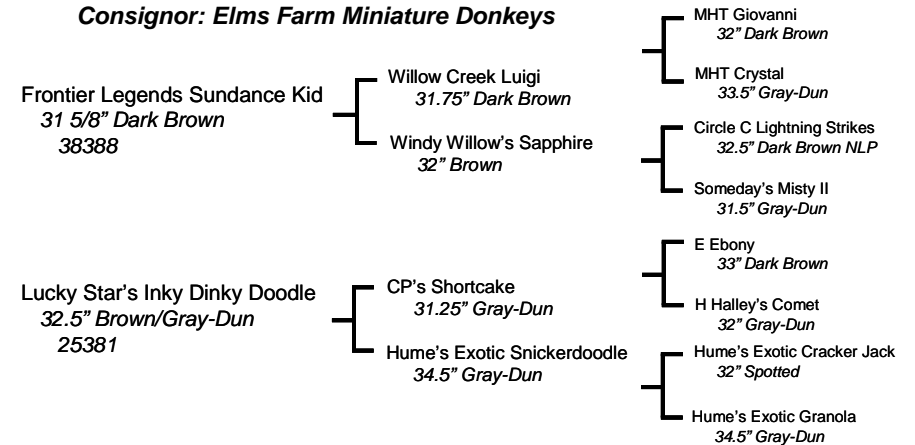

Maggie is a classy jennet! Super well built. She has a great personality, willing, gentle and not pushy. Her 2011 foal sold fast off our farm, and this year's foal, The Elms Magnetism (sired by Geronimo), is just as nice. Maggie has been bred to our small dark brown and white spotted herd sire, D'Artagnan, for a 2013 foal.

18

Hill's Haven Suki

Brown & White Spotted Jennet, 9/26/11, Reg. #62050

Consignor: Hill's Haven

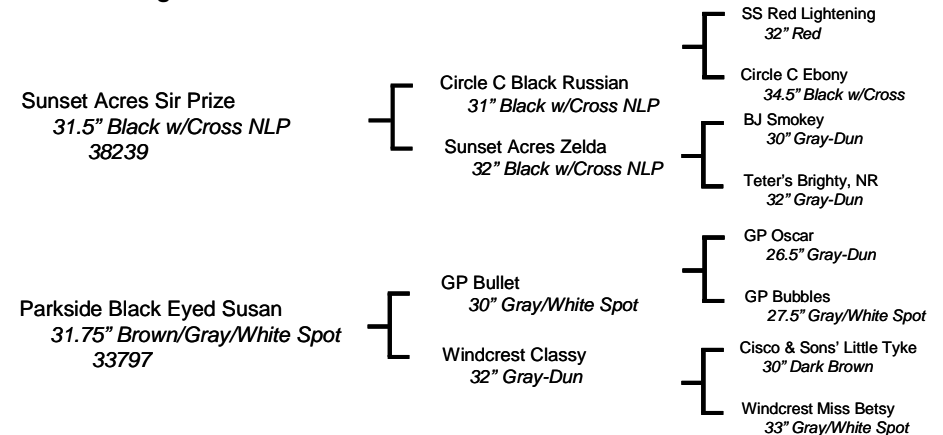

Now here's a gorgeous spotted jennet. Meet Suki. With the deep black genetics on her sire's side and the small spot genetics on her dam's side, she has great colors in her future. Brighten up your pasture and your breeding program with this versatile doll.

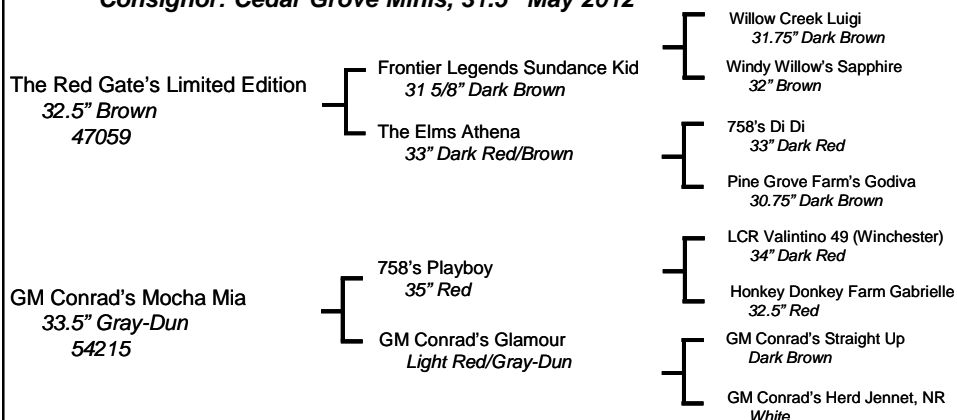
19 Cedar Grove *Pretty Penny***Brown/Red Jennet, 8/10/10, Reg. #62157****Consignor: Cedar Grove Minis, 31.5" May 2012**

Penny is a super sweet and correct coming 2 year old. She demonstrates the compact stocky attributes from her sire, The Red Gate's Limited Edition, a pairing of Frontier Legends Sundance Kid & The Elms Athena. Her full pedigree includes other greats; Lightning Strikes, Di Di, and Playboy. Her lovely reddish brown color with light points, as well as her laid back, personable disposition makes her a 'winner' for any breeding program.

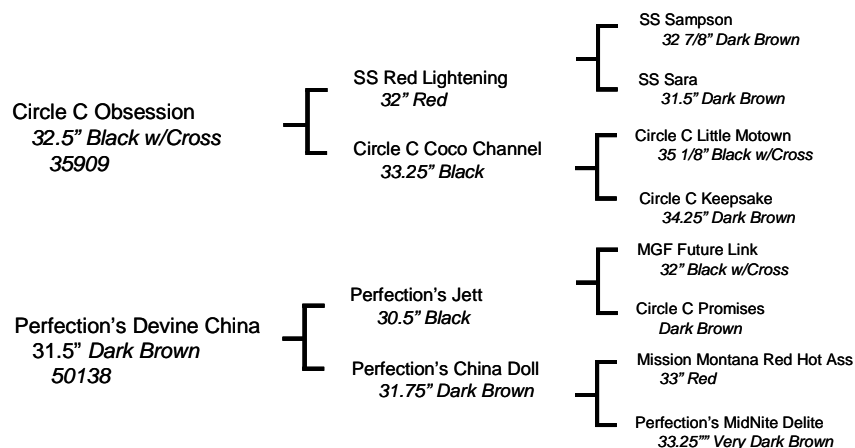
20 Hill Co Mini's *Sugar Baby***Black w/Cross Jennet, 11/17/11, Reg. #Pending****Consignor: Hill Country Miniatures, 21.5" at Birth**

Sugar Baby is a very short, tanky girl who will be super in the show ring. She has a nice round rump, beautiful head, straight legs, and lots of chrome. A very nice example of what her World Champion father throws. Show her now and have an outstanding brood jennet later.

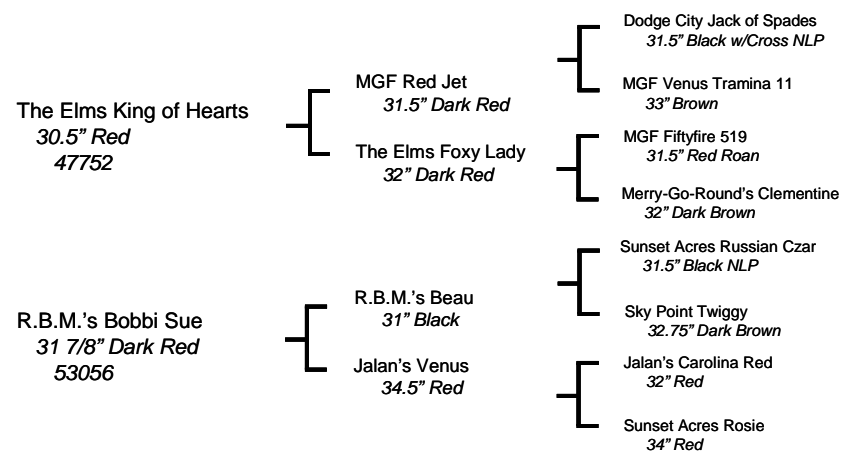
21 The Elms *Bobbi Lou***Dark Red Jennet, 6/1/11, Reg. #Pending****Consignor: Elms Farm Miniature Donkeys, 30" June 2012**

Bobbi Lou is a stocky, wide, correct little jennet, with a pretty head. Her lovely russet red color comes from her mother. Super Nice little jenny- take her home!

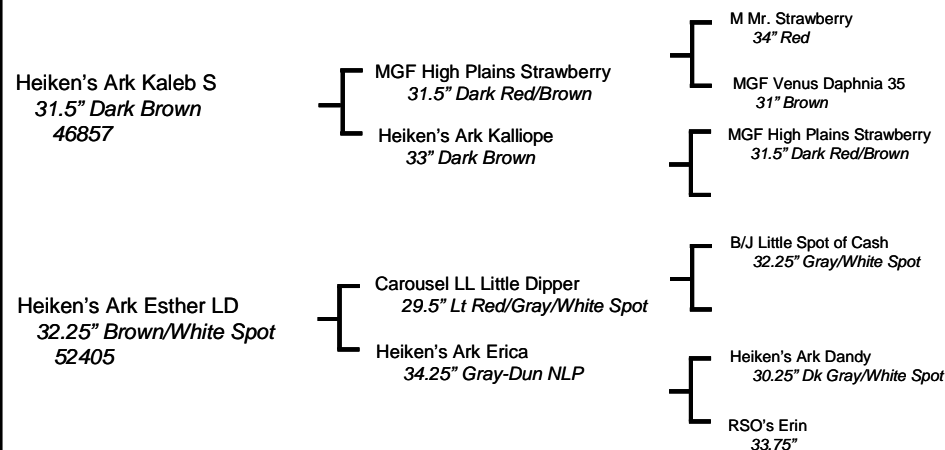
22 Heiken's Ark *Essie K***Gray & White Spotted Jennet, 7/6/09, Reg. #59072****Consignor: Heiken's Ark, 32.5" June 2012**

Essie K is a nice spotted jennet with a stocky build and a good pedigree. She will be three years old at sale time and is open so you can put her with your favorite jack. No surprises here.

23 Hill's Haven *Lola*

Brown Jennet, 9/18/11, Reg. #62049

Consignor: Hill's Haven

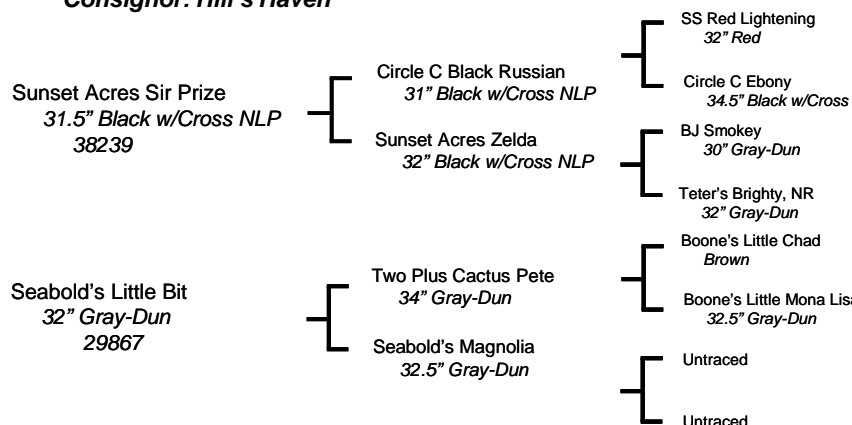

Lola is staying small, is correct and should give you great color. She has black on the sire's side from Sir Prize, Black Russian and red from Red Lightening. This girl is close to the Mediterranean Foundation bloodlines having in the 4th generation on her dam's side, Carlos C 24 and Nanetta N 92, with lots of early numbers on the sire's side as well. She's about as close as you can get to the originals today. Take a good look at Lola.

24 Assphalt Acres *Reeces Pieces*

Dark Red Jennet, 4/4/11, Reg. #62455

Consignor: Assphalt Acres, 21" at Birth

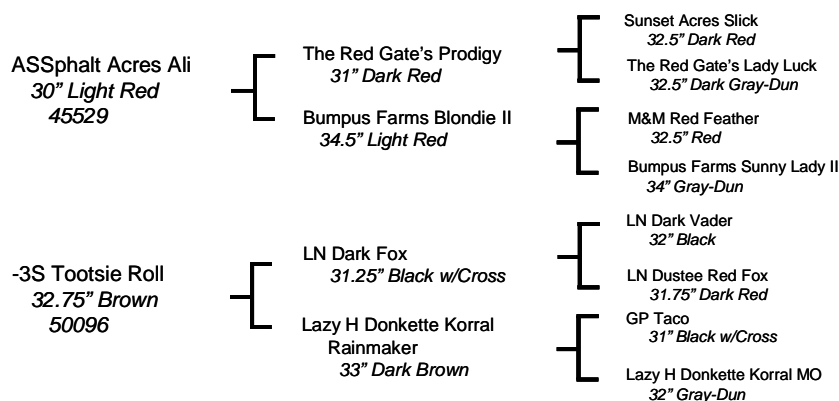

Just like candy, what flavor of donkeys fits your fancy? Reece's Pieces is a nice looking, little jennet that gets her color from her dam, and her drafty conformation and size from her sire, Ali. Whether your plans are in the show ring, or adding a unique future brood jennet, she is probably your girl!

25 West Prairie *Jayla*

Brown Jennet, 4/15/05, 32" Reg. #49330, Bred for 2013

The Elms *Pablo Picasso*

Black w/Cross Jack Foal, 4/19/12, Reg. #Pending

Consignor: Elms Farm Miniature Donkeys

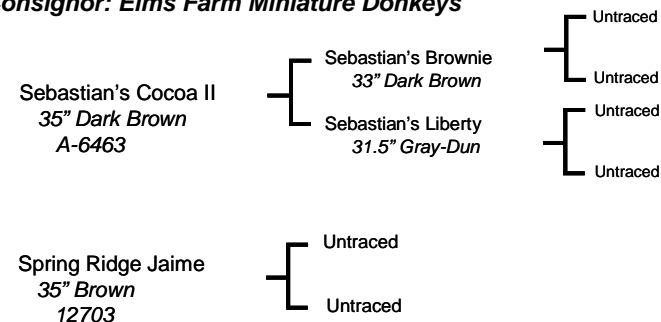

Jayla is a very high quality brood jennet. Don't let her limited, known pedigree fool you, the genetics are good with this jennet. She is the mother of 3 small, and fancy, black foals. We exported Miss Fancy Pants to France, one we retained to be a herd sire, and this foal, by the coal black The Elms Rembrandt. Jayla has been bred to our new small spotted herd sire, The Elms Mosaic, for 2013, to see what she can do with spots.

26 Ass-pirin Acres *Abegail*

Red Jennet, 5/25/11, Reg. #62192

Consignor: Ass-Pirin Acres, 30 1/16" March 2012

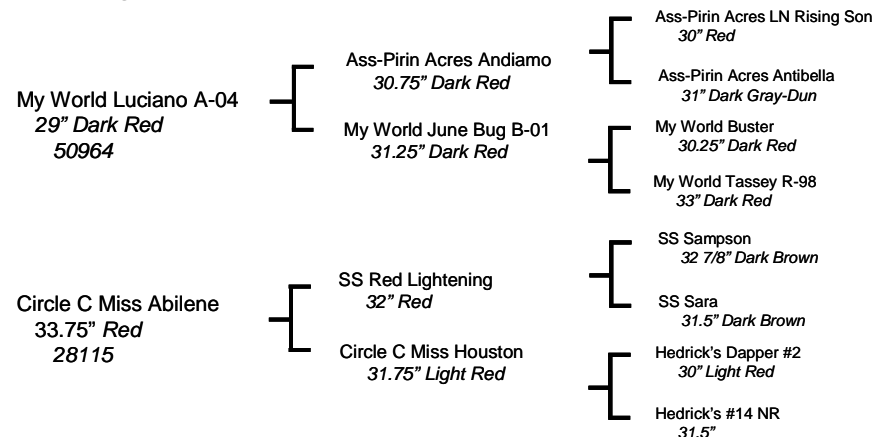

Abegail comes from great stock. Her Canadian dam has the title of World Champion Jennet, among other high honors. Her sire's side is very impressive. And, so is Abegail herself! She's very nicely balanced, a pretty red color, and has a super disposition. Abegail's a quality jenny you will be proud to have in your herd.

27 *H.C.F. Angelica June*

Dark Brown NLP Jennet, 6/17/10, Reg. #Pending

Consignor: Horse Creek Farm, 29.5" April 2012

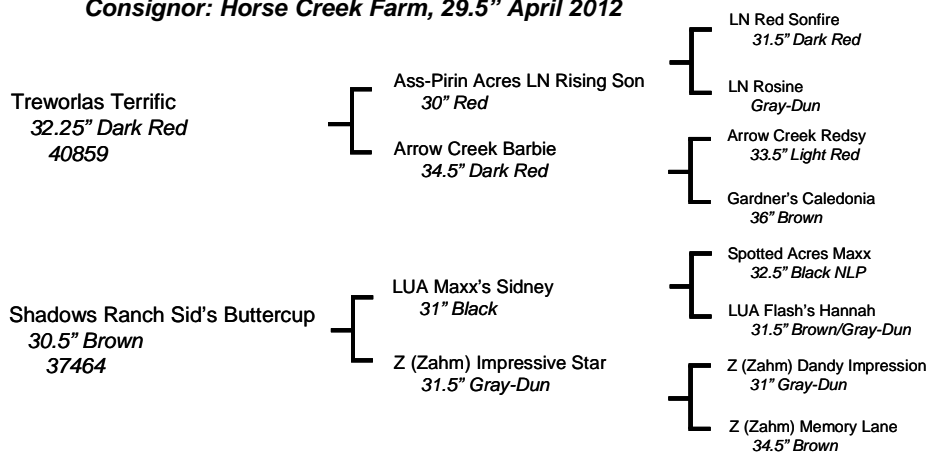

Personality oozes from this small, well balanced 2 year old we call 'Jelly June'. We've turned down numerous offers on her, as she was just too fun to part with. With another year to mature, its hard to believe she can get anymore beautiful! Horse Creek Farm does not breed for quantity, nor do we buy and resell. Our focus is on quality. We choose to breed only a few jennets per year.

28 *Designer Donkeys Venus*

Light Red Jennet, 11/30/11, Reg. #62225

Consignor: Designer Donkeys, 19.5" at Birth

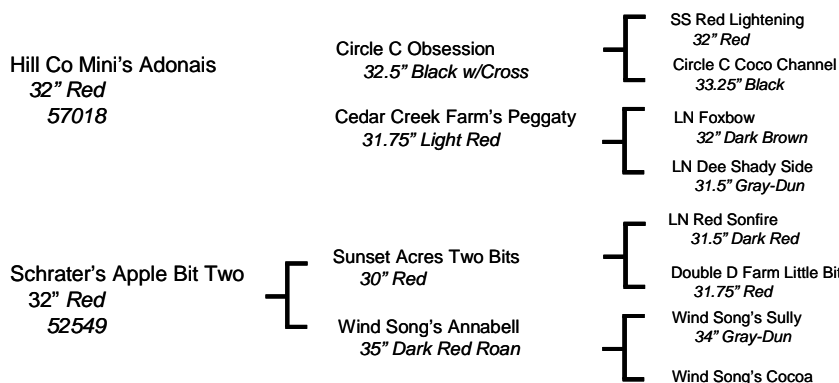

Meet Venus, a nice small light red jennet with conformation and personality that creates a winning combination. She's is our first jennet by Hill Country Mini's Adonais sired by World Champion Circle C Obsession. Her dam, Apple Bit Two, sports a nice red pedigree that includes Red Sonfire and Jennie Sam. Consider Venus for a top show prospect now and a great brood jennet later.

29 *The Elms Spice is Nice*

Dark Red Jennet, 4/14/11, Reg. #61555

Consignor: Elms Farm Miniature Donkeys, 31.5" May 2012

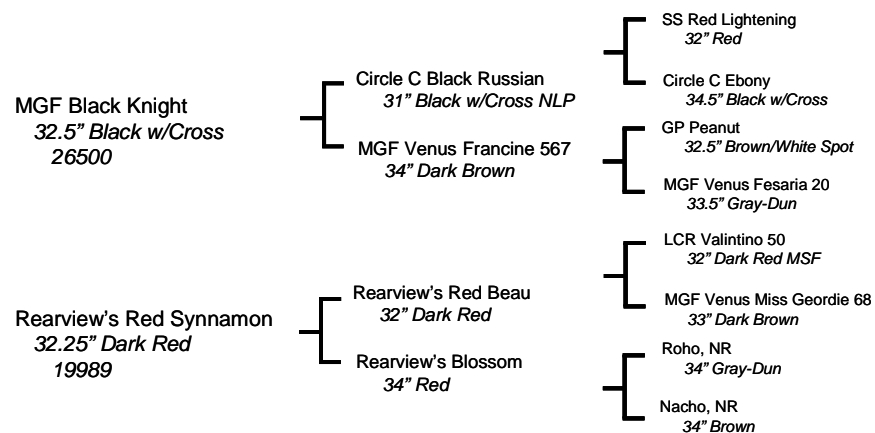

Spice is by a sire of proven excellence, and we consider Synnamon a fabulous brood jennet. It takes both the sire and dam to make a really great donkey. We have retained 2 full sisters to Spice in our breeding herd. Well built, feminine, elegant, rich dark red color, lots of appeal to this jennet. Spice is really nice!

30 *Hill Co Mini's Eternity*

Very Dark Brown Jennet, 9/29/10, Reg. #61455

Consignor: Hill Country Miniatures, 31" March 2012

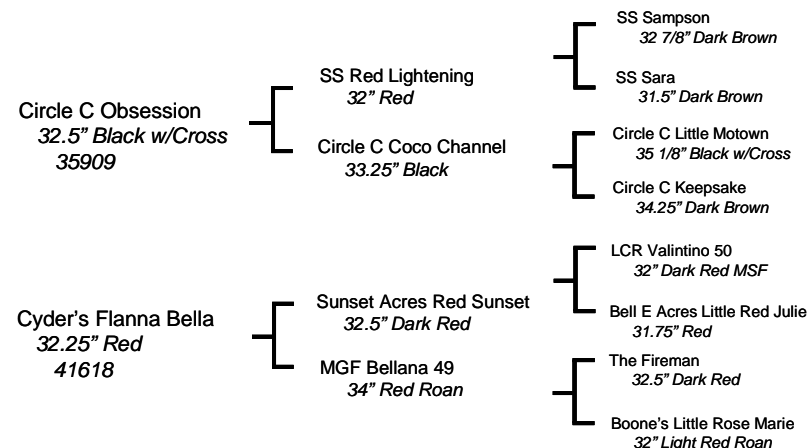

Eternity is the daughter of World Champion Halter Jack, Obsession, and Cyder's Flanna Bella. She is visually very dark brown, but her pedigree is loaded with red & black genetics from exceptional donkeys like Red Lightning, Coco Chanel, Valintino 50, and The Fireman. She is royally bred and will be an excellent show and brood jennet.

31 Continental *Misty Morning*

Red/Gray-Dun Jennet, 4/8/10, Reg. #61018

Consignor: Continental Farm

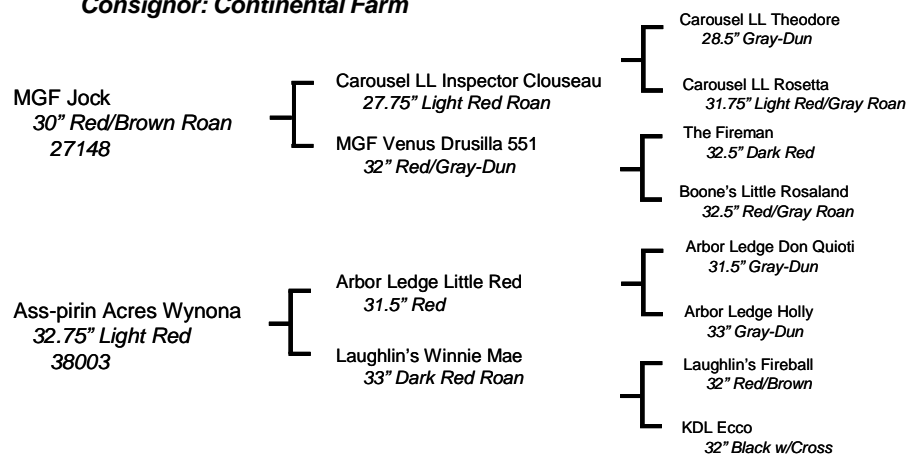

Wynona is still making great music and here is a nice example of her work from a couple of years ago. Misty Morning is a well balanced 2+ year old jennet with very good conformation. She's another example of the great offspring that Jock continues to deliver. Misty gets her name honestly as she is that misty red color. When bred to a red jack, we expect you should get a nice, deep red foal.

32 RBF *Buck*

Gray-Dun Gelding, 6/8/07, Reg. #61633

Consignor: Ravenwood Farm, 34.5" Driving Gelding with Harness

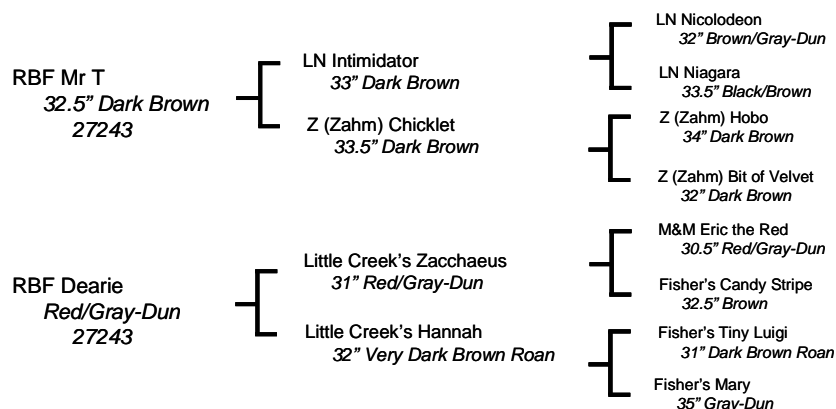

Buck is a very gentle, classic trained gray gelding. He responds to reins and/or voice commands. He also has been trained for In Hand performance classes and enjoys the challenge. Buck sells with a custom made harness. He's a great driver, performance donkey, and family pet all in one. It's hard to find a nice trained driver that someone is willing to part with. Don't pass on Buck.

(Easy Entry Driving Cart available day of Sale – sold separately)

33 Arcadian *Melody II*

Brown Jennet, 10/5/11, Reg. #61719

Consignor: Arcadian Exotics, 26" March 2012

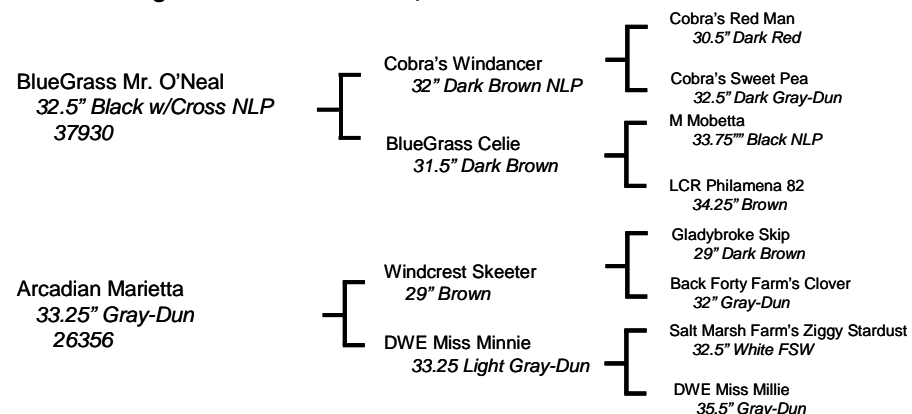

Melody is a small brown jennet with an outstanding pedigree including; Red Man, Motown, and Skeeter. Her sire, Mr. O'Neal, is a well built black jack. Her dam has been a good black producer for us. We've kept some full sisters in our herd, but decided to offer this Melody II to you. If you want a future brood jennet that adds dark color genes to your breeding program, with a great pedigree, a good size and conformation, then Melody is for you!

34 Ass-Pirin Acres *Twinkle Toes*

Red Jennet, 4/30/11, Reg. #62189

Consignor: Ass-Pirin Acres, 21" at Birth

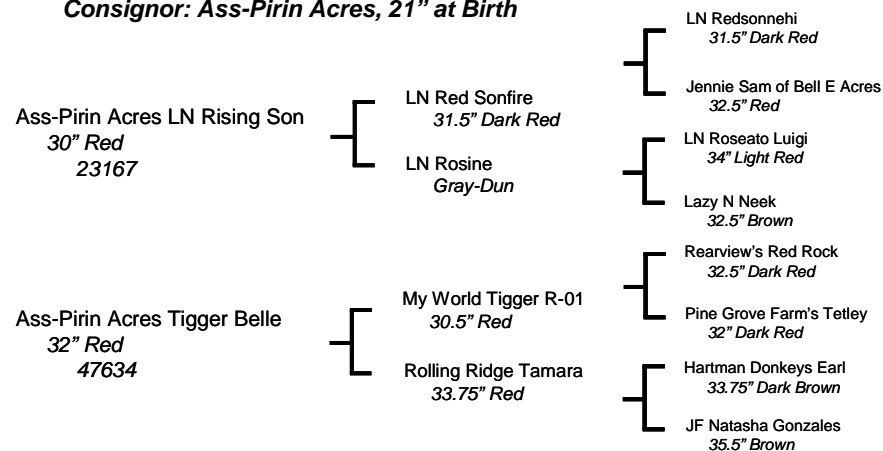

Short, wide, balanced. Twinkle Toes is a beauty and red besides! Put this girl in the ring and collect the ribbons! This girl will make you proud and happy. Look at her pedigree – pretty impressive!

35 Braying Hills *Cherry-ette*

Dark Red Jennet, 6/6/07, Reg. #51638

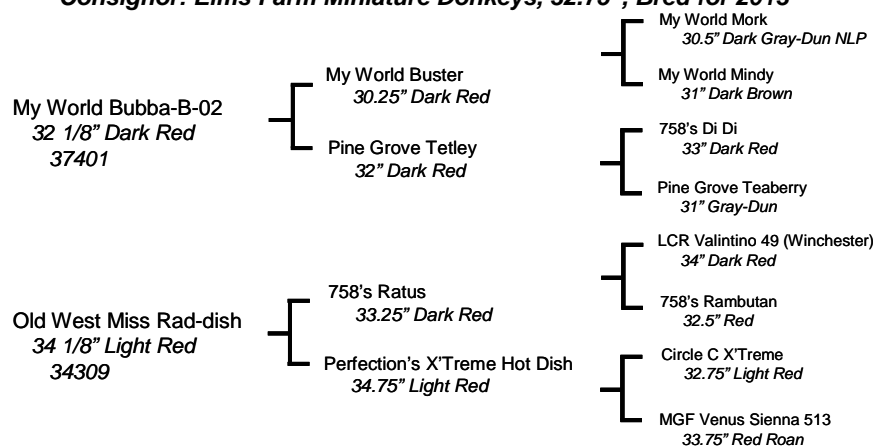
Consignor: Elms Farm Miniature Donkeys, 32.75", Bred for 2013

Cherry-ette is a stocky jenny, very representative of the excellent build of the foundation red jacks. She goes back to Winchester, Rose Bud, Red Lightening, Buster and The Fireman. Smooth, well muscled, drafty build, good balance, and feminine as well. She is one of those quiet jennets you tuck in your herd, breed her right, and get quality foals. Her first foal is stocky and wide. She has been bred to our dark red Fiftyfire son, The Elms Burning Ring of Fire, for a 2013 foal.

36 Shadows Ranch *Sid's Bubbles*

Black Jennet, 7/2/03, Reg. #37463

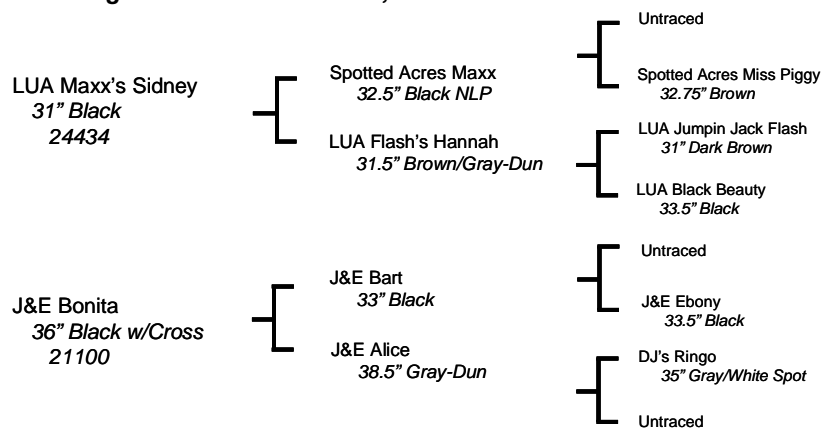
Consignor: Horse Creek Farm, 33"

Bubbles as been at our farm since she was 6 months old. With 'Bubbsie', what you see is what you get; good looks, nice size, rich black color, and the graceful lines of a beautiful, mature, proven breeder. We've retained a jet black daughter in our herd. I have to admit it pains me to now offer her for sale. Take her home and breed her to your jack. You'll be ever so glad you did!

37 Ass-pirin Acres *Angelica*

Dark Brown Jennet, 4/18/11, Reg. #62191

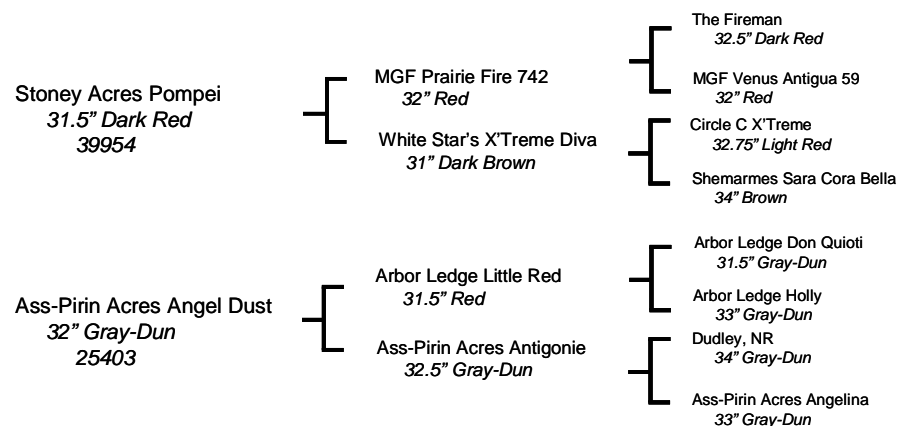
Consignor: Ass-Pirin Acres, 21.25" at Birth

Angelica has it all! Excellent build, super sound mind, flashy rich dark brown coat, and an excellent pedigree. She is the product of our 'Golden Cross' program; a Little Red daughter crossed with Pompei. The resulting foals have the excellent straights we all want in our breeding herd. Add structure and top genetics to your herd with Angelica. She will make you proud.

38 Hill Co Mini's *Solara*

Dark Red Jennet, 11/3/11, Reg. #Pending

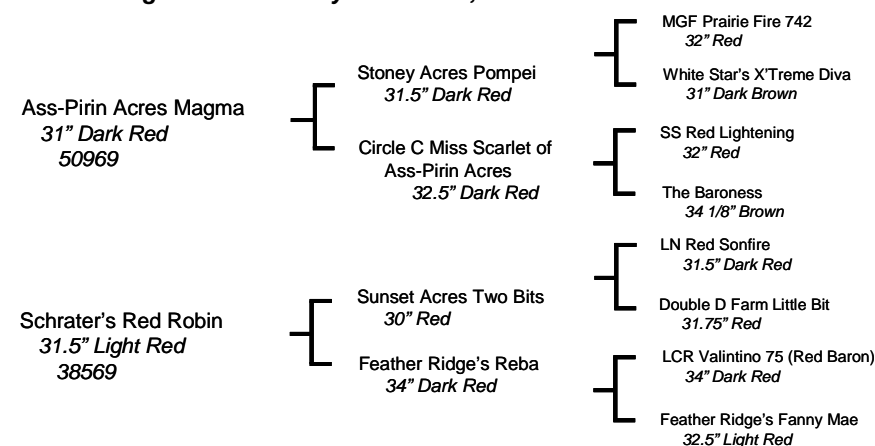
Consignor: Hill Country Miniatures, 21" at Birth

Solara is a gorgeous, showy dark sorrel jennet with a perfect leg set, great rump, and wonderful top line. Her sire is a multiple NMDA Champion that we exported to England. Her mother is a tiny, stocky red jennet with foals in Belgium and England. She has a pedigree loaded with very famous sorrel donkeys. She is show trained and ready for her career!

39 Hill's Haven *Vakita*

Dark Brown NLP Jennet, 5/30/10, Reg. #59649
 Consignor: Hill's Haven

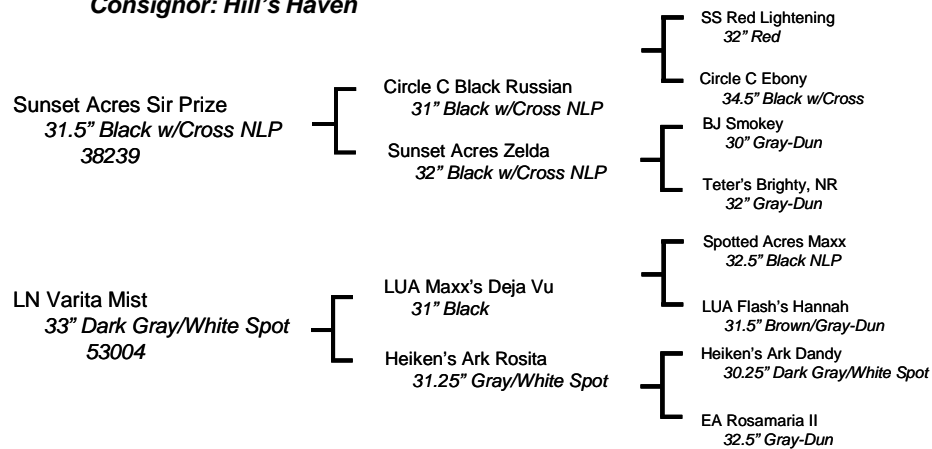

Hill's Haven is offering this nice 2 year old for your consideration. Vakita combines spot blood lines with Sir Prize's very black genetics. This jennet can go both ways, into a bold spot breeding program, or for black. She's going to be ready to breed very shortly so if black or spots is your thing, step up to the plate.

40 Arcadian *Angel*

Brown Jennet, 8/20/11, Reg. #61715
 Consignor: Arcadian Exotics, 27.5" March 2012

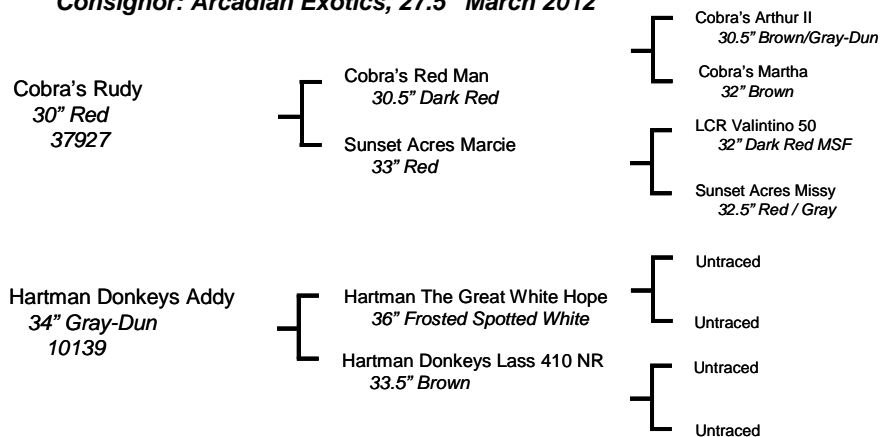

An Angel from the Heavens! Angel is a very correct, small brown yearling who will be a great asset to your breeding program. She's sired by our wonderful jack Rudy, a 30" dark red, who has produced many reds over the years. Her dam, Addy, now age 21, is being retired due to old age. Addy's sire, Hartman's The Great White Hope! If you need a correct brown jennet in your program, seriously consider Angell!

41 Heiken's Ark *Velvet KT*

Very Dark Brown Jennet, 9/12/09, Reg. #59087
 Consignor: Heiken's Ark, 31" June 2012

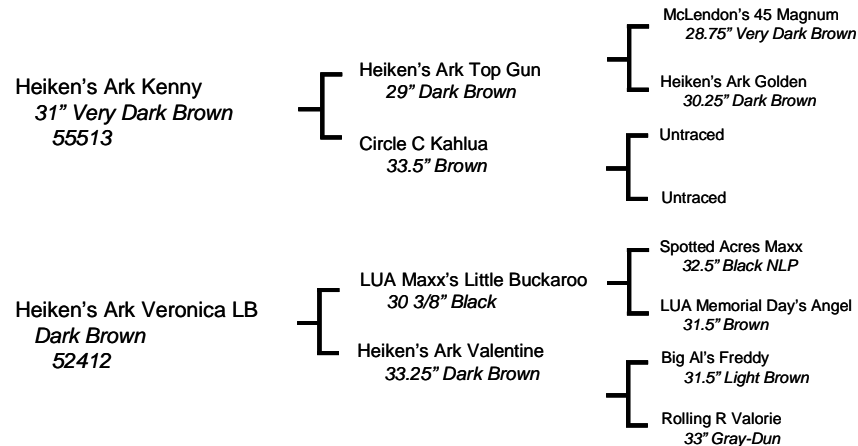

Velvet KT is a small, very dark brown jennet. Her pedigree is full of black and brown. With Magnum in her pedigree you don't want to overlook her. She will be three years old in September and is open to breed to your jack.

42 The Elms *Chica Boom*

Very Dark Brown Jennet, 4/24/04, Reg. #39178
 Consignor: Elms Farm Miniature Donkeys, 33.25", Bred for 2013

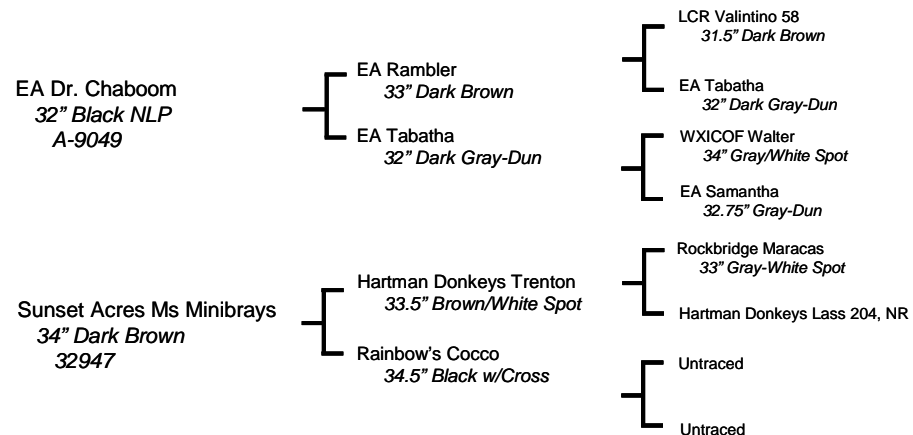

Chica is a stocky, smooth, well built jennet. She has a very willing temperament, will do anything you ask. She has stocky, wide, straight foals with a good temperament. One is a herd sire in Ohio. Chica has been bred to our small spotted jack, The Elms Mosaic, for 2013.